



ISSN: 2454-9940



**INTERNATIONAL JOURNAL OF APPLIED
SCIENCE ENGINEERING AND MANAGEMENT**

E-Mail :
editor.ijasem@gmail.com
editor@ijasem.org

www.ijasem.org

creation of a modified Z-source integrated DC charger and inverter for PV, grid, and electric vehicles

¹Mr. V.Saidulu Assistant Professor, ²Mr. Venkateswar Rao Assistant Professor

Abstract:

Based on the sun's rays For residential and semi-commercial uses, energy has been the most common source of sustainable power. Storage structures may be used to mitigate fluctuations in the amount of sunlight-based vitality that can be harvested due to meteorological circumstances. Solar power may also be used to recharge electric car batteries, reducing the need for a network. Such applications need a converter that has fewer alterations organised and provides solitude. Using the Z-source inverter (ZSI) design, many stages are eliminated, allowing for single-stage voltage raise and DC-AC power conversion. Latent sections may also be used to integrate energy storage systems (ESS) into the system. In order to charge the batteries of electric cars (EVs), this study shows how a modified Z-source inverter (MZSI) works in conjunction with a split essential secluded battery charger. The notion of the suggested converter's activity has been shown by reenactment and exploratory results.

Energy storage, photovoltaic (PV) power production, single-phase systems, and transportation electrification are only a few of the topics covered in the index of articles on qZSIs..

I. INTRODUCTION

The use of alternating current power infrastructure is now heavily reliant on charging electric automobiles. Wireless charging and plugging in, even though they are more efficient topologies, may still pollute the environment since they simply use the AC grid. When you know how much fossil fuels are utilised to generate the power required to charge the vehicle, it's much simpler to assess an electric vehicle's carbon impact. One way to reduce carbon footprints is to include renewable energy sources into a charging infrastructure. In order to build an EV battery charger, isolation transformers are a must since they provide galvanic isolation between the user and the

rest of the high voltage (HV) system [1]. On the AC grid or on the charger, galvanic isolation may be implemented. Grid-side isolation transformers tend to be larger than charger-side isolation transformers. [2] High frequency switching has made it possible to reduce the size of galvanic isolation transformers owing to semiconductor technological developments. Solar grid-coupled systems [3] have been employed in commercial charging infrastructure in the past. The AC grid benefits as a consequence of these technologies. Using a solar and grid-interconnected charging

³Mr. B.Sreenu Assistant Professor
Department of EEE Engineering,
Pallavi Engineering College,

system for electric vehicles (EVs) at home may be advantageous. Household applications up to 10 kW may be powered by single-phase inverters [4][5]. Home solar PV may be connected to the grid in a variety of ways, including isolated and non-isolated topologies [4]- [6]. Home PV EV charging systems must have features like isolation and voltage boost capabilities in order to match the voltage of the solar PV array to grid requirements.. This topology, known as ZSI, first appeared in [7]. In a single stage, DC input voltage may be inverted, bucked, or boosted. There has been a lot of interest in photovoltaic grid-connected applications. The ZSI design makes use of two capacitors and two inductors to boost the DC input voltage to satisfy the inverter's AC output

voltage specifications. The passive components of a ZSI must play a substantial role in order for it to function properly. This system may incorporate an energy storage device.

An application for a string inverter arrangement has been shown in this study using a single phase MZSI based solar grid linked charger. In part II, we looked at how a ZSI works and the components that go into it. The converter is modelled and controlled in Section III, which deals with component size, modelling, and control. Simulated findings for a 3.3kW proposed inverter charger and experimental data from a proof-of-concept are presented in Section

IV. Section V, the conclusion, is found here.

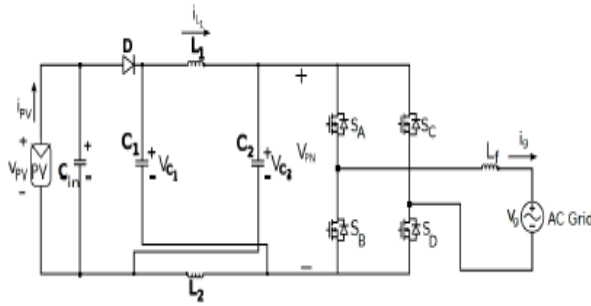

Fig. 1. Schematic of a Photovoltaic/AC grid inter-connected Z-source Inverter(ZSI)

II. TRADITIONAL ZSI

There are two modes of operation for the ZSI structure depicted in Fig.1: shoot through and non shoot through [7]. For symmetrical procedures, use

$$i_L = i_{L1} = i_{L2} \quad (1)$$

$$V_C = V_{C1} = V_{C2} \quad (2)$$

S1, S3, S2, and S4 are all on at the same time during the shoot-through condition. Longevity of this shoot through state is measured by duty cycle (D0) and switching frequency (FSW). The shoot-through condition may be achieved using a modified PWM technique described in [7]. Thus, the voltages of the two capacitors are as follows:

$$V_C = \frac{1 - D_0}{1 - 2D_0} v_{pv} \quad (3)$$

As a result, the input voltage to the DC connection, VP^N, is kept at a greater peak value. According to [7], the highest DC link voltage VP^N is:

$$V_{PN} = \frac{1}{1 - 2D_0} v_{pv} \quad (4)$$

The power balance equation between the DC and AC side of the ZSI is expressed as [7],

$$(1 - D_0)V_{PN}I_{PN} = i_{grms}v_{grms} \quad (5)$$

where IPN and VP^N are the peak DC link current and voltage. The peak AC voltage of the ZSI is [7]:

$$V_g = MV_{PN} \quad (6)$$

where the M is the modulation index, grid voltage, $v_g = V_g \sin \omega t$ and the grid current $i_g = I_g \sin(\omega t + \phi)$. For $\phi = 0$ for grid connected applications. From equation (11) and (13) the RMS of the output AC voltage of the ZSI is [7]:

$$V_{grms} = \frac{Mv_{pv}}{\sqrt{2}(1 - 2D_0)} \quad (7)$$

III. COMPONENT SIZING, MODELING AND CONTROL OF PROPOSED MZSI

Fig. 2 shows a modified Z source inverter has been proposed having an integrated charger. The two capacitors C1 and C2 from Fig.1 are split and each of them act as one of the legs of one of the two primaries of the split primary isolated half bridge converter. The MOSFET SR allows bidirectional operation of the MZSI when required. The diode DPV blocks the reverse flow of current back into the PV. Rin is the internal resistance of the input

capacitor C_{in} . For symmetrical operation of the MZSI, a split primary isolated DC to DC converter has been proposed for the integration of the charger side into the ZSI. The split primaries contain two half bridge converter (HBC) primaries isolated from a single full bridge secondary through a high frequency transformer. The HBC primaries and the secondaries are operated at 50% duty cycle in open loop. The output current of the secondary is connected to a energy storage unit such as a lithium-ion (Li-ion) battery. The energy storage unit clamps its own voltage, v_B , across the input of the HBC primaries, V_C , such that,

$$V_C = 2v_B \quad (8)$$

A. Maximum Shoot Through Duty Ratio, D_{0max}

As a result of the energy storage unit being connected across the capacitors, the maximum shoot through duty ratio, D_{0max} is calculated based on the minimum input voltage, v_{pmin} and the maximum battery voltage, V_{Bmax} connected across the capacitors and is expressed as:

$$D_{0max} = \frac{2V_{Bmax} - v_{pmin}}{4V_{Bmax} - v_{pmin}} \quad (9)$$

SAE J1772 standard defines the standard battery voltages for DC charging between 200V-500V.

B. Inductor L_1 and L_2 design

The inductors L_1 and L_2 are sized for high frequency peak to peak current ripple assumed between 15-25% of the

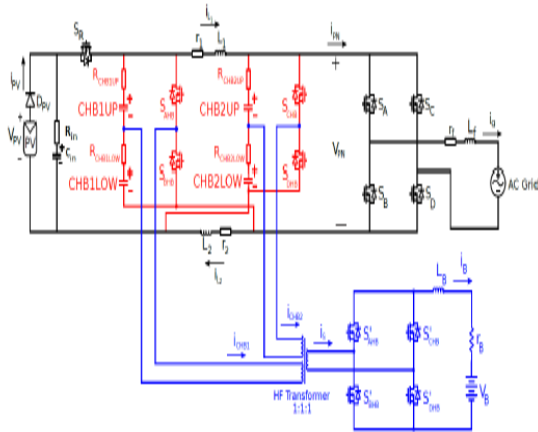

Fig. 2. Detailed Schematic of Proposed MZSI inductor current during the shoot-through time interval $D_{0T}/2$ as follow [8]:

$$L_1 = L_2 = \frac{V_{Cmax} D_{0max}}{2\Delta i_L f} \quad (10)$$

C. Capacitor C_1 and C_2 design

They are sized to absorb the second-order harmonic component of capacitor voltages as follows: [8]

$$C_1 = C_2 = \frac{P}{2\omega\Delta V_C V_C} \quad (11)$$

where ΔV_C is the specified voltage ripple limit and V_C is the average voltage across the capacitors V_{C1} and V_{C2} . ω is the second-order harmonics represented in radians per second. Oversized electrolytic capacitors for second order harmonic suppression in single phase Z source inverters might lead to a large system. Capacitance may be reduced using a DC side Active Power Filter (APF) like the one presented in [9]. It is not reliant on the MZSI to function. There must be at least twice as much capacity in the capacitor as the energy storage device clamped across it for the suggested design.

D. Average Modeling of the Integrated Half-Bridge DCDC Converter Charger

When an energy storage device is attached to the charger's secondary side, the charger's split primaries function alternately and provide half of the battery current needed. In the DC-DC converter, each of the converter's primary is linked to the capacitor on each leg of the converter. Capacitors are characterised by their voltage across the equation (15). In [10], the split main DC-DC converter's thorough average modelling is discussed. The simplified equivalent model of the Fig.4 shows that each of the two primaries may be represented by an RLE circuit connected parallel to each of the capacitors, C_1 and

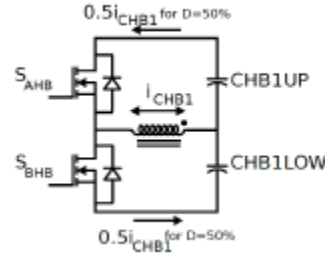

C_2 .

Fig. 3. Schematic of one the Primary across CHB1 operating at 50% duty cycle.

E. State Space Average Modeling of the Single Stage

Inverter Charger The detailed state space average modeling was presented in [10]. The equivalent diagram of the modeled MZSI is shown in the Fig. 4, During the non shoot-through state, the KVL equation is given by:

$$L \frac{di_L}{dt} = v_{pv} - i_L r + R_{HB} + (2i_g + \frac{i_B}{2})R_{HB} - V_C \quad (12)$$

The KCL equation is:

$$C \frac{dV_C}{dt} = i_L - i_g - \frac{i_B}{4} \quad (13)$$

During the shoot-through state, the KVL equation is:

$$L \frac{di_L}{dt} = V_C - i_L(R_{HB} + r) - \frac{i_B}{2} R_{HB} \quad (14)$$

The KCL equation is written as:

$$C \frac{dV_C}{dt} = -i_L - \frac{i_B}{4} \quad (15)$$

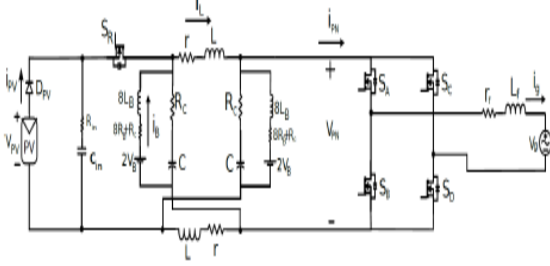

Fig. 4. Equivalent Model of the proposed Modified Z-source Inverter(MZSI) with battery
From equation (12)-(15), state space equations for the entire system can be written as:

$$\begin{bmatrix} \dot{i}_L \\ \dot{V}_C \\ \dot{i}_B \end{bmatrix} = \begin{bmatrix} \frac{-(r+2R_{HB})}{L} & \frac{1-2D_0}{L} & \frac{(1-2D_0)}{2} R_{HB} \\ \frac{1-2D_0}{C} & 0 & -\frac{1}{4C} \\ \frac{1-2D_0}{L_B} R_{HB} & \frac{1}{2L_B} & -\frac{R_{HB}+R_B}{2L_B} \end{bmatrix} \begin{bmatrix} i_L \\ V_C \\ i_B \end{bmatrix} + \begin{bmatrix} \frac{2(1-D_0)R_{HB}}{L} \\ -\frac{1-D_0}{C} \\ -\frac{(1-D_0)R_{HB}}{L_B} \end{bmatrix} i_d + \begin{bmatrix} \frac{(1-D_0)}{L} \\ 0 \\ 0 \end{bmatrix} v_{pv} + \begin{bmatrix} 0 \\ 0 \\ -\frac{1}{L_B} \end{bmatrix} V_B \quad (16)$$

Fig. 4 shows the positive directions of the battery current, i_B and i_g , the grid-side AC current, respectively. The suggested MZSI topology's controller block diagram is shown in Figure 5. The PV current i_{pv} loop, the grid current i_g loop, and the battery current i_B loop make up this system.

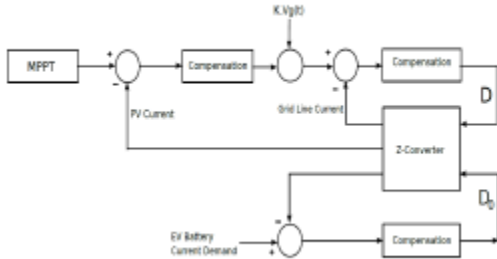

Fig. 5. Block diagram of the Control Scheme Proposed Modified Zsource Inverter Charger

For H-Bridge inverter output current [11] or D_0 shoot-through duty ratio [12], voltage control of the ZSI capacitor is used in literature. The peak photovoltaic input current is controlled in this study to create the reference current [13]. Both capacitors

will have an effect on the shoot-through duty ratio, D_0 , when V_C is applied across them. Battery current loop control has the slowest reaction time compared to input current control since it does not need rapid dynamic changes. The transfer function is provided by the battery loop control:

$$\frac{I_B(s)}{d_0(s)} = \frac{-sC[4R_{HB}i_L - 2R_{HB}i_d] - [2i_L - i_d]}{2L_B C s^2 + sC[R_{HB} + 2R_B] + 0.25} \quad (17)$$

A feedforward is added to the battery control loop,

$$FF_B = \frac{2V_B - v_{PV}}{4V_B - v_{PV}} \quad (18)$$

where V_B is the output voltage of the HBC and v_{PV} is the tracked PV voltage. The output AC side current controller should have the fastest response.

F. Energy Management Scheme for the Proposed Converter

The suggested system is shown schematically in Fig. 6 (below). Equation (5) is altered as follows [14] when an ESS is incorporated into a ZSI:

$$v_{PV}i_{PV} = v_b i_b + i_{grms} v_{grms} \quad (19)$$

PB is maintained at the ESS because of the single phase AC grid power P_g , which counteracts the variability in power from the PV source P_{pv} . When pulling power from the grid to charge an EV battery, the direction of the AC grid current typically switched from positive to negative. The charger is powered by the PV and the grid, which may be used to drive the inverter in both directions.

$$v_{PV}i_{PV} + i_{grms} v_{grms} = v_b i_b \quad (20)$$

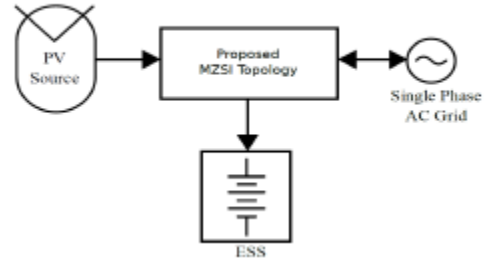
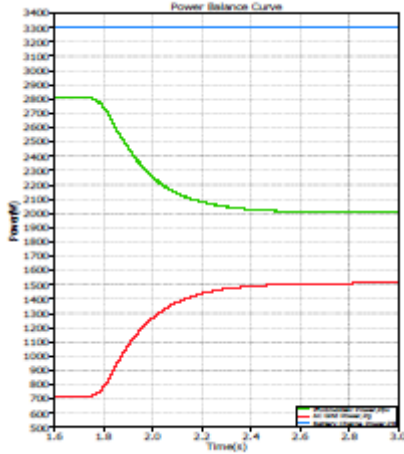

Fig. 6. Simplified Block Diagram of the System



Simulated waveform for power balancing between PV, AC grid, and battery power shown in Fig. 7. Photovoltaic power, the AC grid, and battery power The MZSI may be used as a grid-connected rectifier/charger if the voltage across the input capacitor C_{in} is kept to at least the minimum value of the PV voltage. [15]-[16]. Previous research on ZSI topology anti-islanding protection approaches may be found in [17].

IV. SIMULATION AND EXPERIMENTAL RESULTS

A. Simulation study for a MZSI operation

The simulation studies to demonstrate the behaviour of the proposed topology have been carried out using PLECS 4 for a 3.3 kW charger for a string inverter configuration. Simulation has been carried out for the system shown in Fig.2 Fig.7 shows at simulation time $t=1.75$ s, the input PV power reduces from 2.8 kW to 2 kW, the grid power increases from 710 W to 1500 W to maintain the output charger power to 3.3kW and the corresponding grid current, DC link voltage, capacitor voltage and the battery current is shown in Fig.8.

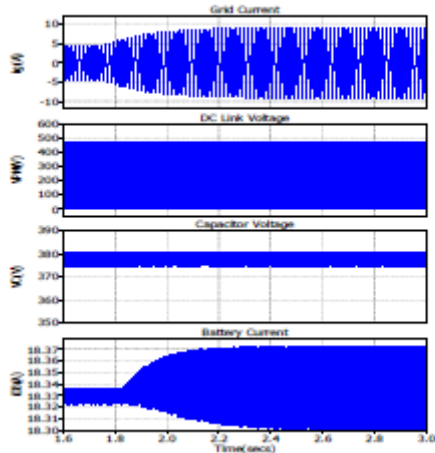

Fig. 8. SimulationWaveform of the grid current, I_g , DC link voltage, V_{PN} , Capacitor Voltage, V_{C1} , and Battery current, i_b for the power balance between the Photovoltaic input power, the AC Grid side and the battery power.

TABLE I MODIFIED ZSI BASED CHARGER SYSTEM SIMULATION SPECIFICATIONS

Parameters	Value
Input Voltage, V_{in}	286 V
Input Current, I_{in}	9.8 A
Inductor Value, $L_1=L_2$	500 μ H
ZSI Switching Frequency, F_{SW}	25 kHz
Grid Voltage (RMS), V_g	240 V
Inverter Output Filter Inductor, L_f	7.5 mH
PV Input Power, P_{PV}	2.8 kW
Input Capacitor, C_{in}	2 mF
HBC Switching Frequency, f	50 kHz
HBC Output Filter, L_B	1 mH
Battery charge power, P_B	3.3 kW

TABLE II COMPONENT MODELS USED FOR LOSS MODELING OF THE PROPOSED SYSTEM

Component	Value
Diode, D	STTH6010W
ZSI MOSFETs [S_A , S_B , S_C and S_D]	APT28M120L
HBC MOSFETs [S_{AHB} , S_{BHB} , S_{CHB} and S_{DHB}]	APT28M120L
HBC Diodes, [S'_{AHB} , S'_{BHB} , S'_{CHB} and S'_{DHB}]	STTH6010W
Capacitor, C_{in} , C_1 and C_2	ECE-T2VP182FA

B. Loss Modeling

The loss modeling for the proposed system shown in Fig. 2 has been carried out by modeling the actual components in PLECS 4.0. The switching components used for the modeling is shown in the Table II, For the loss modeling of the passive components, the internal resistance of the inductors, L_1 , L_2 and L_f are $r=100$ m and the ESR, RHB for the capacitors C_1 , C_2 and C_{in}

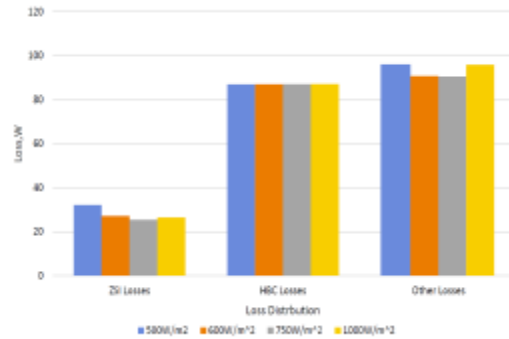

Fig. 9. Loss distribution chart for the MZSI topology for a fixed charging power $P_B=3.3$ kW at 25 $^{\circ}$ C, under varying irradiation

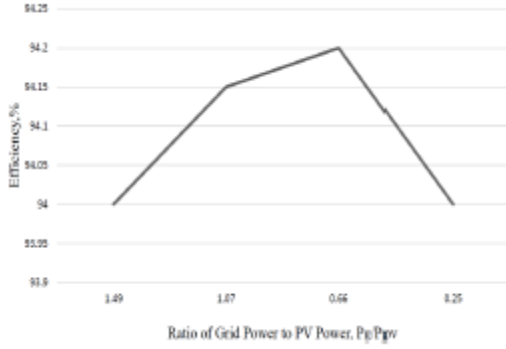

Fig. 10. Efficiency curve for different ratios of AC Grid Power P_g to Photovoltaic Power P_{pv} curve for a fixed charging power $P_B=3.3$ kW at 25 °C under varying irradiation are 138 m.

Fig. 9 shows the loss distribution between the ZSI (conduction and switching losses of the MOSFETs and diode D), the HBC (conduction and switching losses of the MOSFETs and secondary diodes) and other losses in due to the inductor, capacitors, leakage losses in the high frequency transformer and battery series resistances in the system for varying irradiations for a constant charging power $P_B=3.3$ kW. Fig. 10 shows the efficiency is around 94% from the efficiency curve for various ratios of AC Grid Power, P_g , to Photovoltaic Power, P_{pv} for a fixed charging power, $P_B=3.3$ kW at 25 °C, for varying irradiation between 500W/m² to 1000W/m². Although the efficiency variations is small, the efficiency is the highest when the sharing between the photovoltaic power P_{pv} and the grid power P_g is equal. For a constant frequency of operation, the HBC MOSFET losses remain constant for a fixed value V_B and charging power, P_B . Although in reality, this might not be the case. The efficiency of the converter will change with the change in the battery voltage. Fig. 11 shows the distribution of the losses between the ZSI losses, the HBC MOSFETs and the losses due

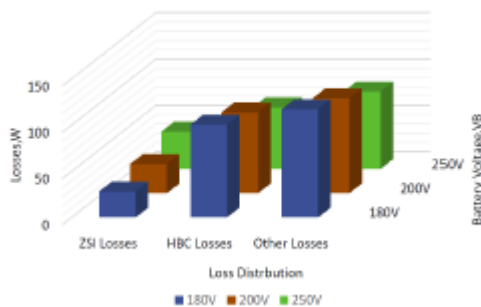

Fig. 11. Loss distribution for various battery voltages, V_B , for a fixed charging power, $P_B=3.3$ kW, at 45 °C

TABLE III MODIFIED ZSI BASED CHARGER SYSTEM PROTOTYPE ELECTRICAL SPECIFICATIONS

Parameters	Value
Input Voltage, V_{in}	38 V
Input Current, I_{in}	3.82 A
Inductor Value, L_1 & L_2	500 μ H
Peak DC Link Voltage, V_{PN}	63.33 V
Modulation Index, M	0.75
Shoot Through Duty Ratio, D_{0MAX}	0.2
Switching Frequency, F_{SW}	25 kHz
Grid Voltage, V_g	34 V(RMS)
Inverter Output Filter Inductor, L_f	2.5 mH
HBC switching frequency, f_{HBC}	50 kHz

transformer and battery series resistances in the system for various battery voltages. From Fig.11, at 45 °C, the v_{pv} drops to 258V and it can be observed that with the increase in battery voltage the ZSI losses increase but the HBC losses and the losses in the passive components reduce.

C. Experimental Verification of the MZSI power balance operation

In this paper as proof of concept, a scaled down 175W experimental setup was built using MATLAB/Simulink and

dSPACE 1103. The setup has the following specifications shown in table III. Fig. 12 shows the PWM scheme for the HBC. Each of the split primary operate for half the HBC switching period. Each MOSFET SAHB, SBHB, SCHB and SDHB operates exclusively for one quarter of the entire HBC switching period. Equation (23) can be written in terms of the current sharing between the AC load(grid) and the battery as:

$$i_{PV} = \frac{1 - D_0}{2(1 - 2D_0)} i_b + \frac{M}{\sqrt{2}(1 - 2D_0)} i_g \quad (21)$$

where M is the modulation index and D_0 is the shoot through duty ratio. For $D_0=0.2$,

$$i_{PV} = \frac{2}{3} i_b + \frac{\sqrt{3}}{2} i_g \quad (22)$$

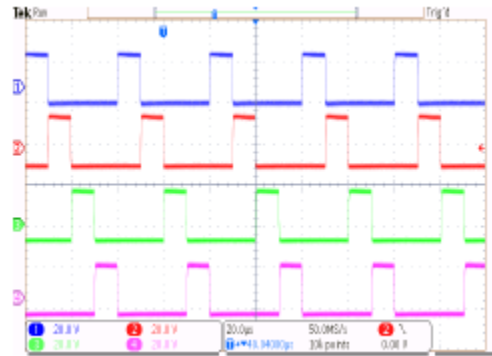

Fig. 12. PWM logic for the isolated HBC

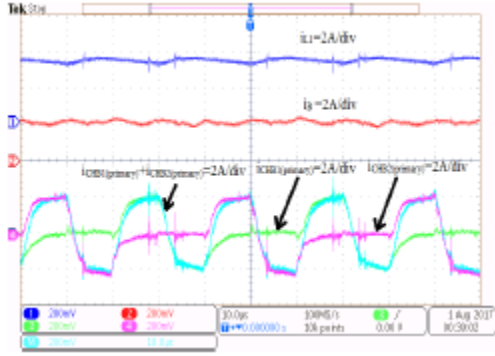

Fig. 13. Experimental setup waveforms for the Inductor current(top), charger output current(middle) and the primary currents of the split charger(bottom) From equation (22), at $D_0=0.2$, for an input current $i_{PV}=3.82$ A and fixed HBC output current $i_B=2$ A, the ZSI AC output current i_g is calculated to be 2.87 A. Fig.13 shows the the inductor current i_{L1} , the battery current i_B and the split primary current i_{CHB1} and i_{CHB2} and the total primary current. Each of the primary operate alternately. The total primary current is a high frequency alternating current of $f_{HBC}=50$ kHz. From Fig. 13 and Fig. 14, the charger output current is maintained at 2 A using a Chroma Programmable AC/DCElectronics Load(Model 6304). The PV input current is maintained at 3.82 A using a Magna-power LXITM solar emulator. The output grid current is observed to be 2.66 A. Fig. 15 shows the experimental setup for the proof of concept. The lower values of the output current is a result of the losses in the circuit. The practical PI values for the ACside current control was $K_P=0.03$ and the battery loop was $K_{PB}=0.0003$ and $K_{IB}=0.09$ and the input PV current loop were $K_{Pin}=0.005$ and $K_{Lin}=2$.

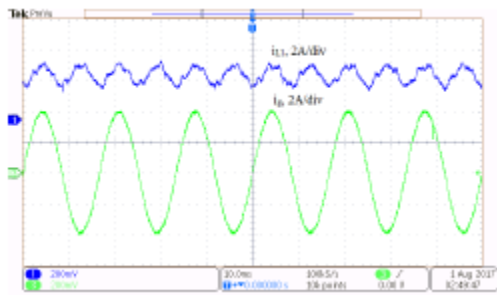

Fig. 14. Experimental waveform input current(blue) and output current(green) between the charger and the AC output of the MZSI

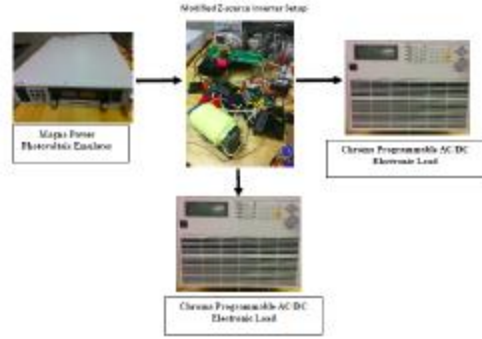

Fig. 15. Experimental setup
Table Iv Isolated Half Bridge Dc-Dc System Electrical Specifications

Parameters	Value
Input Voltage, V_C	50.667 V
Output Voltage, V_B	25.335 V
Switching Frequency, $F_{sw(HB)}$	50 kHz
Filter inductor, L_B	330 μ H

V. CONCLUSION

A modified ZSI architecture has been described in this research provides an intriguing option for solar grid linked charging systems. It comprised of a single stage photovoltaic grid (PV-Grid) connection and an integrated charger for PV-Grid linked charging or energy storage. This topology may be used to centralised setup for charging in semi-commercial places such as a parking lot of a shopping mall. For residential applications, this notion may be expanded to string inverters with the charger side of the string inverter configurations coupled in series or parallel for current sharing. The research presents a new energy storage design employing Z source converter through\ssymmetrical functioning of its impedance network.

REFERENCES

- [1] D. Aggeler, F. Canales, H. Zelaya, D. L. Parra, A. Coccia, N. Butcher, and O. Apeldoorn, "Ultra-fast dc-charge infrastructures for ev-mobility and future smart grids," in Proc. of IEEE PES Innovative Smart Grid Technologies Conference Europe, pp. 1–8, Oct. 2010.
- [2] G. Carli and S. S. Williamson, "Technical considerations on power conversion for electric and plug-in hybrid electric vehicle battery charging in photovoltaic installations," IEEE Trans. on Ind. Electron., vol. 28, no. 12, pp. 5784–5792, 2013.
- [3] J. G. Ingersoll and C. A. Perkins, "The 2.1 kw photovoltaic electric vehicle charging station in the city of santa monica, california," in Proc. of the

Twenty Fifth IEEE Photovoltaic Specialists Conference, pp. 1509–1512, May. 1996.

- [4] S. B. Kjaer, J. K. Pedersen, and F. Blaabjerg, “A review of single-phase grid-connected inverters for photovoltaic modules,” *IEEE Trans. on Ind. Appl.*, vol. 41, no. 5, pp. 1292–1306, Sep. 2005.
- [5] N. A. Ninad, L. A. C. Lopes, and I. S. Member, “Operation of Single-phase Grid-Connected Inverters with Large DC Bus Voltage Ripple,” *Proc. of the IEEE Canada Electrical Power Conference*, 2007.
- [6] S. Bai, D. Yu, and S. Lukic, “Optimum design of an ev/phev charging station with dc bus and storage system,” in *Proc. of IEEE ECCE*, pp. 1178–1184, Sep. 2010.
- [7] F. Z. Peng, “Z-Source Inverter,” in *IEEE Trans. on Ind. Appl.*, vol. 39, no. 2, pp. 504–510, 2003.
- [8] Y. Huang, M. Shen, F. Z. Peng, and J. Wang, “Zsource inverter for residential photovoltaic systems,” *IEEE Trans. on Power Electron.*, vol. 21, no. 6, pp. 1776–1782, Nov. 2006.
- [9] S. A. Singh, N. A. Azeez, and S. S. Williamson, “Capacitance reduction in a single phase quasi z-source inverter using a hysteresis current controlled active power filter,” in *Proc. of IEEE 25th Int. Symp. on Ind. Electron.*, pp. 805–810, Jun. 2016.
- [10] S. A. Singh, G. Carli, N. A. Azeez, and S. S. Williamson, “A modified z-source converter based single phase pv/grid inter-connected dc charging converter for future transportation electrification,” in *Proc. of IEEE ECCE*, pp. 1–6, Sep. 2016.
- [11] Y. Li, S. Jiang, J. G. Cintron-Rivera, and F. Z. Peng, “Modeling and control of quasi-z-source inverter for distributed generation applications,” *IEEE Trans. on Ind. Electron.*, vol. 60, no. 4, pp. 1532–1541, Apr. 2013.
- [12] T. Chandrashekhar and M. Veerachary, “Control of single-phase z-source inverter for a grid connected system,” in *Proc. of Int. Conf. on Power Syst.*, pp. 1–6, Dec. 2009.
- [13] B. Ge, Y. Liu, H. Abu-Rub, R. S. Balog, F. Z. Peng, S. McConnell, and X. Li, “Current ripple damping control to minimize impedance network for single-phase quasi-z source inverter system,” *IEEE Trans. on Ind. Info.*, vol. 12, no. 3, pp. 1043–1054, Jun. 2016.
- [14] B. Ge, H. Abu-Rub, F. Z. Peng, Q. Lei, A. T. de Almeida, F. J. T. E. Ferreira, D. Sun, and Y. Liu, “An energy-stored quasi-z-source inverter for application

to photovoltaic power system,” *IEEE Trans. on Ind. Electron.*, vol. 60, no. 10, pp. 4468–4481, Oct. 2013.

- [15] J. Rabkowski, R. Barlik, and M. Nowak, “Pulse width modulation methods for bidirectional/high-performance z-source inverter,” in *Proc. of IEEE Power Electron. Spec. Conf.*, pp. 2750–2756, Jun. 2008.
- [16] S. Dong, Q. Zhang, and S. Cheng, “Analysis of critical inductance and capacitor voltage ripple for a bidirectional z-source inverter,” *IEEE Trans. on Power Electron.*, vol. 30, no. 7, pp. 4009–4015, Jul. 2015.
- [17] M. Trabelsi and H. Abu-Rub, “A unique active antiislanding protection for a quasi-z-source based power conditioning system,” in *Proc. of IEEE Appl. Power Electron. Conf. and Expo.*, pp. 2237–2243, Mar. 2015