



ISSN: 2454-9940



**INTERNATIONAL JOURNAL OF APPLIED
SCIENCE ENGINEERING AND MANAGEMENT**

E-Mail :
editor.ijasem@gmail.com
editor@ijasem.org

www.ijasem.org

IOT BASED FIRE FIGHTING ROBOT

Mr. P. A. Prassath, Mr. N. Murugan, Dr. L. Vigneash, Mr. D. Satyaraj

Assistant Professor ^{1,2,4}, Associate Professor ³

paprassath@actechnology.in, nmurugan@actechnology.in,

dr.vigneashl@actechnology.in, dsatyaraj@actechnology.in

Department of ECE, Arjun College of Technology, Thamaraikulam, Coimbatore-Pollachi
Highway, Coimbatore, Tamilnadu-642 120

ABSTRACT

Accidents involving fires have been happening more often recently, whether or not people are involved. The devastating effects of a fire may include human casualties, material destruction, and long-term impairments. When putting out fires, firefighters face increased dangers; this is particularly true in potentially dangerous settings like nuclear power plants, oil refineries, petrol tanks, etc. Additional challenges arise when firefighters must go through building rubble and other obstructions to put out fires and rescue victims in confined spaces. When firefighting operations are fraught with peril, the fire brigade may rely on innovation for assistance. In the event that the robot senses fire, it will communicate with the nodeMCU, which will then start the water pump, update the data on the blynk server, and operate the robot. It aids firemen in putting out the blaze. Also, it will work in areas where firemen are unable to access. Firefighters' lives will be spared and more harm will be prevented.

INTRODUCTION

For firefighters to safely extinguish flames and protect lives, they need to have the necessary expertise and training to access hazardous areas. Danger and difficulty abound in this task. As a result of recent advancements in robotics technology, firefighting robotic vehicles have surfaced as a possible substitute to enhance the safety and efficiency of firefighting operations. In order to do tasks that would be too difficult or perilous for human firefighters, unmanned vehicles equipped with sensors and firefighting gear may access hazardous areas. Firefighting robotic vehicles are the name given to these vehicles. Firefighting equipment is a common accessory for these robotic machines, which may be controlled from a distance. There will be less need for human firefighters to risk injury or death by allowing robotic firefighting trucks to access hazardous areas. Among the many advantages of modern cars, one stands out. In situations when every second counts, robotic systems can keep going for long stretches of time

without taking a break. To conclude, RTVs provide a practical solution to the problems of ineffective and unsafe firefighting. We should expect these systems to become more sophisticated, versatile, and effective in addressing the challenges faced by firefighters in dangerous environments as robotics technology advances.

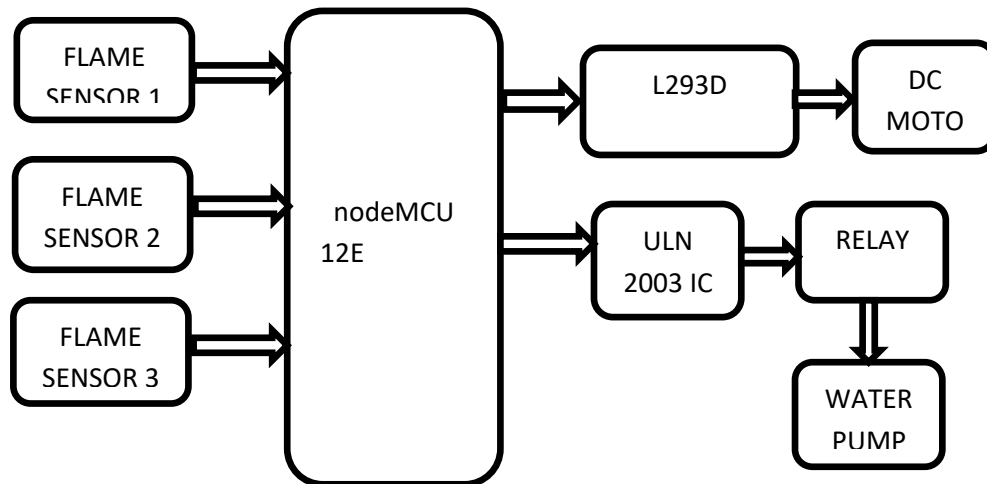

Figure.1 Block diagram

OBJECTIVE OF THE PROJECT

By implementing a novel solution that leverages robots and IoT technologies to aid firefighters in putting out flames, this project aims to reduce the dangers connected with fire occurrences. Improving firefighting teams' skills while decreasing their exposure to harmful conditions is vital due to the rising number of fire incidents caused by both natural and human causes. The following goals are intended to be accomplished by the project: Create an autonomous robotic system that can detect fires in a variety of settings, including potentially dangerous areas like fuel tanks, oil refineries and nuclear power facilities.

When a fire is detected, you may allow real-time communication and data updates by integrating IoT technologies, particularly node MCU and Blynk server. Among these functions is the ability to remotely operate the robotic system and communicate fire alarms to the firefighting squads.

Add capabilities to the robotic system that will allow it to move about in tight spaces and overcome barriers that firefighters often face. To do this, you'll have to climb over steep obstacles to reach locations that have been burned and investigate the remains of buildings.

Make it possible for the robot to detect fires and start battling them on its own, including turning on a water pump to put out the blaze.

PROPOSED SYSTEM

In order to identify and put out flames in dangerous areas, this project is different from other firefighting solutions as it uses robots, Internet of Things (IoT) technology, and autonomous capabilities. Especially in hazardous or inaccessible places, this system may function autonomously, reducing dangers to firefighters and increasing efficiency in firefighting operations compared to conventional approaches that rely on human involvement.

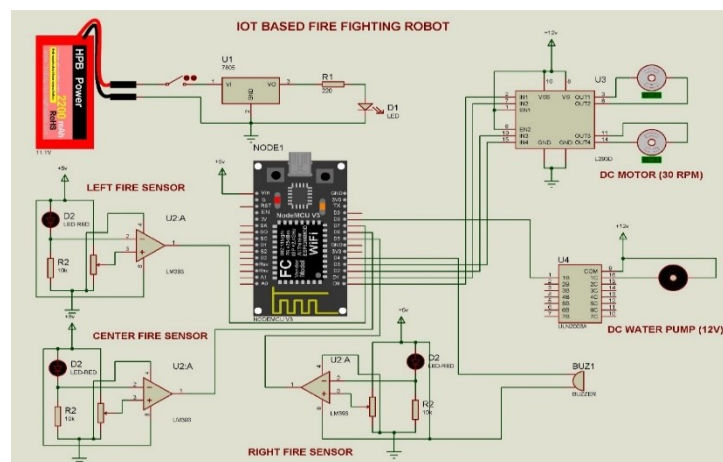

Figure.2 Schematic Diagram

RESULTS



Figure.3 Components



Figure.4 Power supply

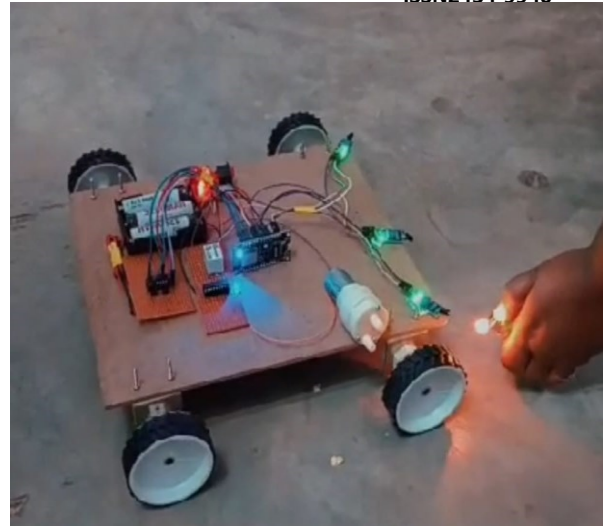
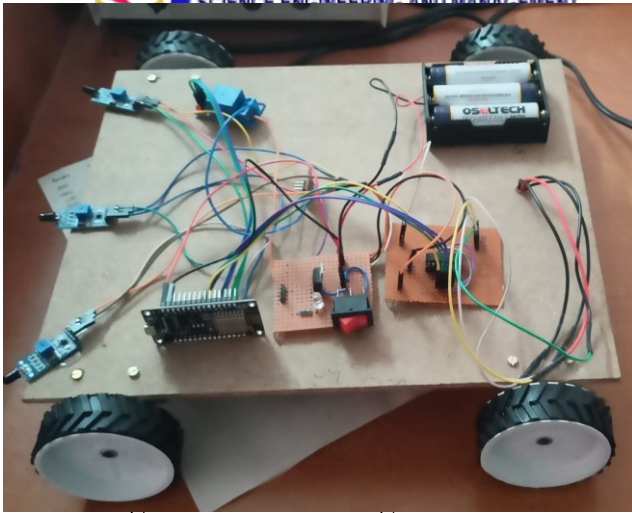

Figure.6 Practical Working

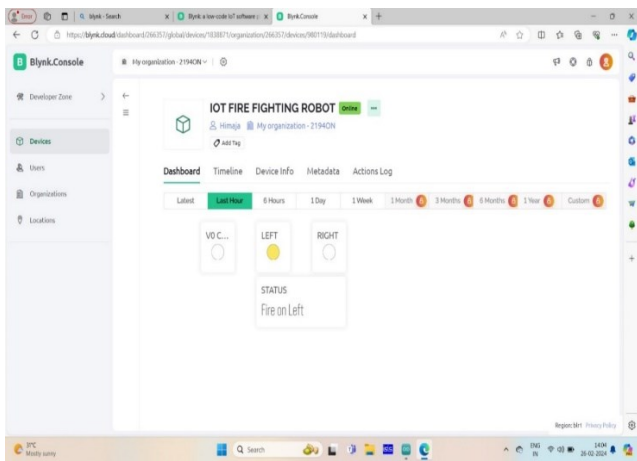

Figure.7 Status Fire on Left

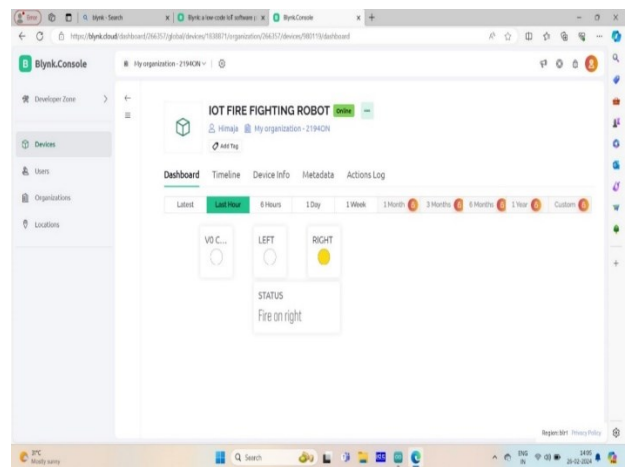

Figure.8 Status Fire on Right

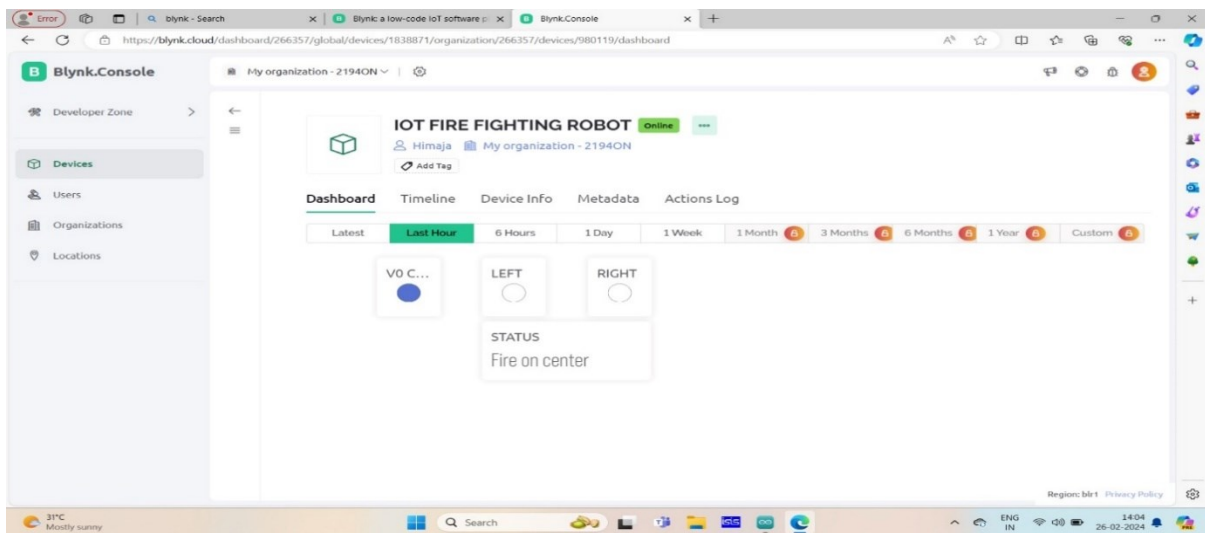

Figure.9 Status Fire on Right

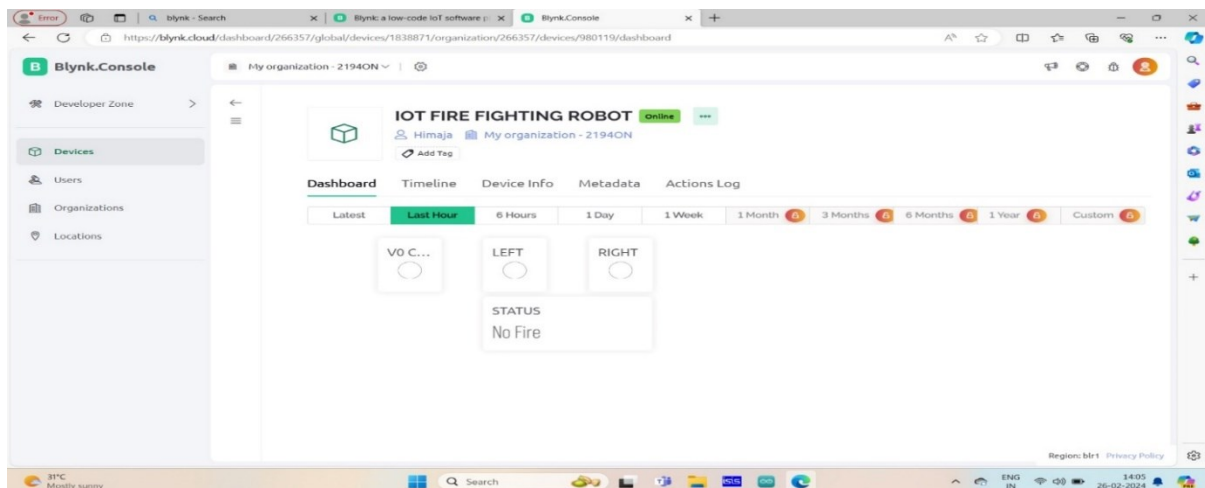

Figure.10 Status No fire

ADVANTAGES

Improved safety for firefighters by reducing their exposure to hazardous environments.
Increased efficiency in firefighting operations through timely detection and Intervention,
Remote monitoring and control capabilities enhance situational awareness for firefighting Commanders.

CONCLUSION

To sum up, our firefighting vehicle is a huge improvement over previous models since it uses cutting-edge technology such a node microcontroller unit (MCU), flame sensor, DC water pump, and Blynk server connectivity. Using the Internet of Things (IoT) and real-time data transfer, our vehicle can respond to fires more efficiently and with greater reactivity. You may remotely operate and monitor the vehicle's operations thanks to the node MCU's flawless communication and control. Having a flame sensor installed improves safety since it may identify fires early on, allowing for quick action to reduce hazards. Additionally, a DC water pump is included to provide a steady supply of water for firefighting operations, and data uploading to the Blynk server allows for thorough data analysis and optimisation of firefighting tactics.

Essentially, our fire truck is much ahead of the curve when it comes to technology, and it's going to change the way fire departments save lives and property. Communities throughout the globe may expect a future that is both safer and more resilient as we work to improve and expand its capabilities.

REFERENCES

1. F. Amigoni, N. Basilico, N. Gatti, and M. Mamei, "Fire-fighting robot teams for industrial applications," *Robotics and Autonomous Systems*, vol. 56, no. 11, pp. 915-930, 2008.
2. G. Lee, S. Kim, and S. Oh, "Design of a firefighting robot using water mist for fire suppression," *Robotics and Autonomous Systems*, vol. 61, no. 4, pp. 425-434, 2013.
3. R. Vanegas, L. J. Manso, R. Fernandez, and J. R. Martinez-de Dios, "Autonomous firefighting robots: Conceptual design, modelling, and control," *Robotics and Computer-Integrated Manufacturing*, vol. 29, no. 2, pp. 260-270, 2013.
4. R. He, F. Xiao, Y. Yang, and D. He, "A review of firefighting robot technology," *Fire Technology*, vol. 54, no. 2, pp. 427-449, 2018.
5. C. Y. Yang, Y. Y. Cheng, Y. H. Wu, and C. L. Yang, "An intelligent robotic system for fire-fighting applications in tunnel environments," *Automation in Construction*, vol. 102, pp. 30-42, 2019.
6. A.G. Smith and S. F. Smith, "Firefighting Robots: A Review of the State-of-the-Art," *Journal of Sensors*, vol. 2019, Article ID 4048531, 16 pages, 2019.
7. M. Yilmaz and M. Terzi, "Design of a fire extinguishing robot," *Journal of Theoretical and Applied Mechanics*, vol. 57, no. 3, pp. 859-871, 2019.
8. S. A. Ahmed, W. A. Mousa, and E. A. Abdelkader, "Firefighting Robot: Review and Future Perspectives," *International Journal of Advanced Robotic Systems*, vol. 17, no. 1, 2020.
9. \L. Wu, Z. Wu, H. Li, and L. Zhang, "Autonomous firefighting robot with distributed multi-sensor fusion system," *Journal of Intelligent & Robotic Systems*, vol. 99, no. 3, pp. 813-825, 2020.
10. C. Liu, Y. Xing, S. Xing, and C. Li, "Firefighting robot based on Internet of Things for smart fire rescue," *IEEE Access*, vol. 8, pp. 233768-233.